

TA8120P

T-77-05-05

C-QUAM<sup>®</sup> AM STEREO DECODER

TA8120P is a C-QUAM<sup>®</sup> AM stereo decoding and pilot detection system IC.

It contains L+R signal detector, L-R signal detector, pilot signal detector and matrix circuit.

It is suitable for DTS automobile radio and others.

- . Full wave envelope detector (L+R signal).
- . PLL detector (L-R signal).
- . No adjustable VCO (Voltage controled oscillator) for PLL detector.
- . Pilot signal (25Hz) detector.
- . Stereo indicator driving.
- . Forced monaural switching circuit.
- . Internal level detector can be used as AGC source.
- . Operating supply voltage :  $V_{CC(opr)}=6\sim 12V$ , ( $T_a=25^\circ C$ )

Unit in mm

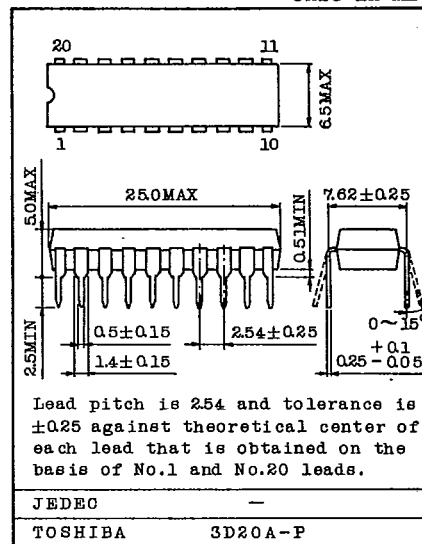

Weight : 1.4g

MAXIMUM RATINGS ( $T_a=25^\circ C$ )

CHARACTERISTIC	SYMBOL	RATING	UNIT
Supply Voltage	$V_{CC}$	14	V
Lamp Current	$I_{15}$	50	mA
Power Dissipation	$P_D^*$	1.2	W
Operating Temperature	$T_{opr}$	-30~85	$^\circ C$
Storage Temperature	$T_{stg}$	-55~150	$^\circ C$

\* : Derated above  $T_a=25^\circ C$  in the proportion of 9.6mW/ $^\circ C$ .

C-QUAM<sup>®</sup> is a trademark of Motorola Inc..

AUDIO LINEAR IC

# TA8120P

BLOCK DIAGRAM

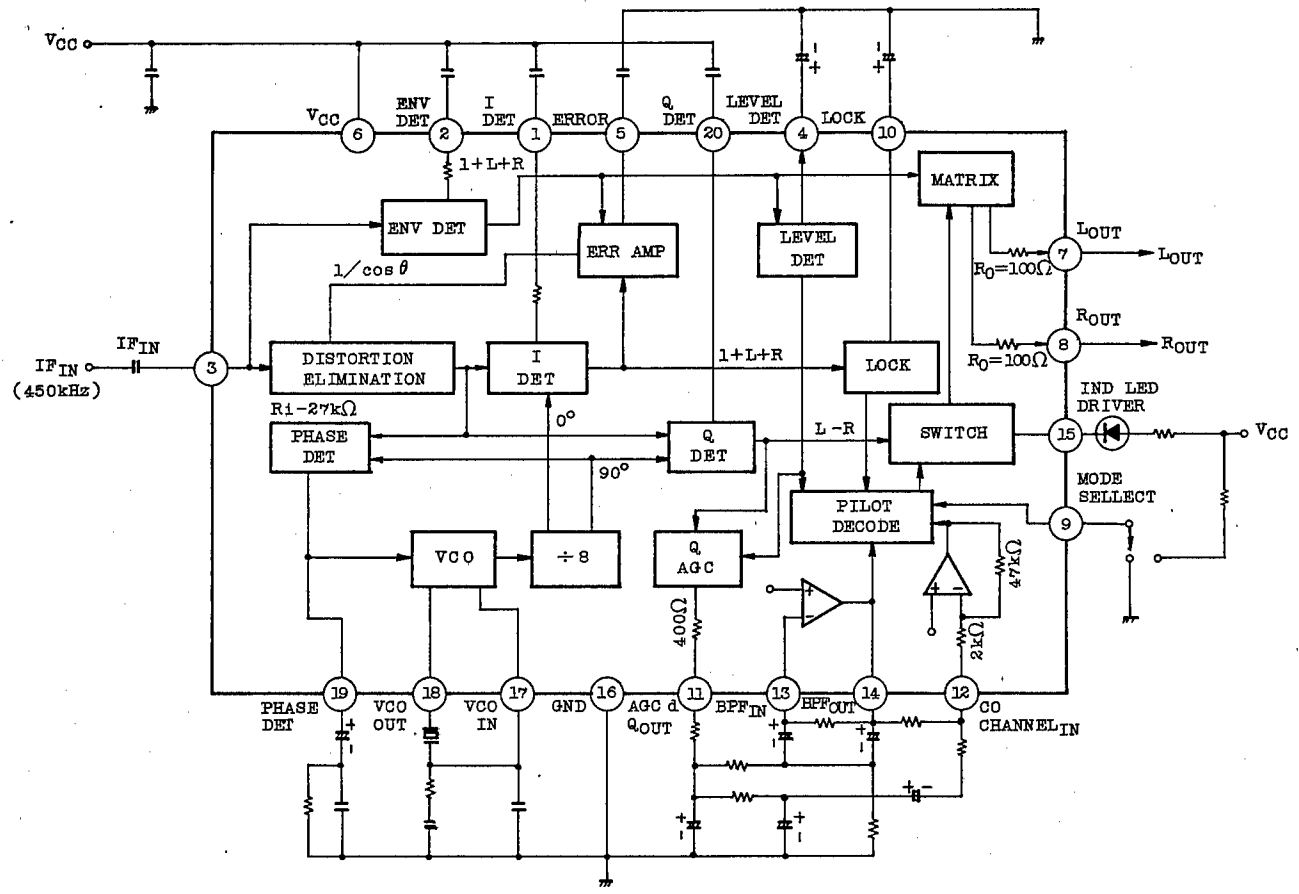

TOSHIBA

**TA8120P**

T-77-05-05

## ELECTRICAL CHARACTERISTICS

(Unless otherwise specified,  $V_{CC}=8.0V$ ,  $f_{in}=450kHz$ ,  $V_{in}=200mV_{rms}$ ,  $f_m=1kHz$ ,  
 $SW1=C$ ,  $T_a=25^{\circ}C$ ,  $L_{OUT}$  and  $R_{OUT}$  are monitored)

CHARACTERISTIC	SYMBOL	TEST CIR-CUIT	TEST CONDITION	MIN.	TYP.	MAX.	UNIT
Quiescent Current	$I_{CCQ}$		$V_i=0$	20	30	40	mA
Input Signal Range	$V_i(opr)$		Unmodulated	100	200	357	mVrms
Audio Output Level	$V_o(st)$		50% Lonly Mod or 50% Ronly Mod P=5% (Note)	160	220	280	mVrms
	$V_o(mono)$		50% Mod	80	110	140	
THD	THD(mono)		50% Mod	-	0.5	-	%
	THD(st)		50% L=R Mod P=5% (Note)	-	1.0	-	
Channel Separation	Sep		50% Lonly Mod or 50% Ronly Mod P=5% (Note)	-	30	-	dB
Pilot Acquisition Time, VCO Locked	$T_{lock}$		After release of forced monaural; $SW1=a \rightarrow c$ , P=5%	-	300	-	ms
Input Impedance	$R_i$		-	20	27	-	k $\Omega$
	$C_i$		-	-	6.0	-	pF
Output Impedance	$R_o$		-	-	100	200	$\Omega$
Level Detector Filter Voltage	$V_4(1)$		$V_i=0$	1.4	1.7	2.0	V
	$V_4(2)$		$V_i=200mV_{rms}$	-	2.5	-	
Lock Detector Filter Voltage	$V_{10}(1)$		In Lock	-	7.8	-	V
	$V_{10}(2)$		Monaural	-	0.8	-	
Force to Monaural Monaural Mode	$V_9(1)$		P=5%, $SW1=b$	2.0	2.5	-	V
Force to Monaural Automatic Mode	$V_9(2)$			-	3.5	3.7	V

Note : After stereo mode is locked,  $P=5\% \rightarrow 0\%$

**TA8120P**

T-77-05-05

## TERMINAL VOLTAGE AT QUIESCENT TIME

(V<sub>CC</sub>=8V, T<sub>a</sub>=25°C, typical value at the test circuit)

PIN No.	TERMINAL	VOLTAGE (V)
1	I·Det	7.4
2	Env·Det	7.4
3	IF in	3.6
4	Level·Det	1.7
5	Error	1.6
6	V <sub>CC</sub>	8.0
7	L <sub>OUT</sub>	0.5
8	R <sub>OUT</sub>	0.5
9	Mode Seselect	8.0
10	Lock	8.0
11	AGC'd Q out	1.0
12	C <sub>0</sub> Channel in	0.6
13	BPF in	0.6
14	BPF out	0.6
15	LED Drive	-
16	GND	0
17	VCO in	2.9
18	VCO out	6.7
19	Phase·Det	3.0~4.3
20	Q Det	7.4



**TA8120P**

T-77-05-05

## 1. AM Stereo of Motorola System

The modulated-wave generation mechanism of motorola system stereo is as shown in Fig.1.

The signal which is balance-modulated by the summed signal (L+R) component of the audio signal, and the signal in which 90° phase-shifted carrier is balance-modulated with the summed signal of the differential signal (L-R) and the pilot signal are produced.

These signals are orthogonally modulated, their AM component is eliminated, and the signals are finally balance-modulated with the summed signal (L+R).

AM stereo modulated wave of Motorola system is provided with a useful merit of orthogonal modulation (multiple broadcasting is possible in narrow band) and has the complete compatibility with the conventional monaural receiver.

This system is called C-QUAM<sup>®</sup> (Compatible Quadrature Amplitude Modulation).

Orthogonal modulation wave

$$E_1(t) = (1+L+R) \cos \omega ct + (L-R) \cos (\omega ct + \pi/2) \\ = \sqrt{(1+L+R)^2 + (L-R)^2} \cos \left\{ \omega ct + \tan^{-1} \frac{(L-R)}{(1+L+R)} \right\} \dots (1)$$

C-QUAM<sup>®</sup> wave

$$E_2(t) = (1+L+R) \cos \left\{ \omega ct + \tan^{-1} \frac{(L-R)}{(1+L+R)} \right\} \\ = \cos \theta \cdot E_1(t) \dots (2)$$

$$\text{Providing } \theta = \tan^{-1} \frac{(L-R)}{(1+L+R)} \quad \cos \theta = \frac{1+L+R}{\sqrt{(1+L+R)^2 + (L-R)^2}}$$

**TA8120P**

T-77-05-05

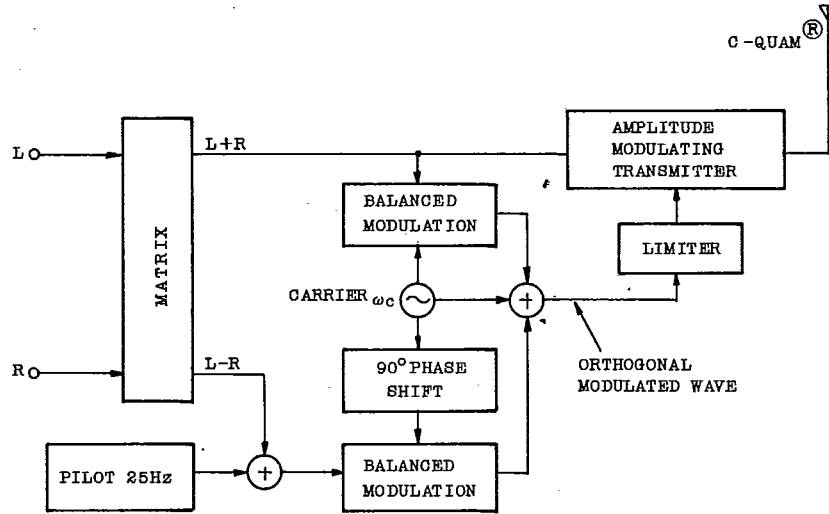
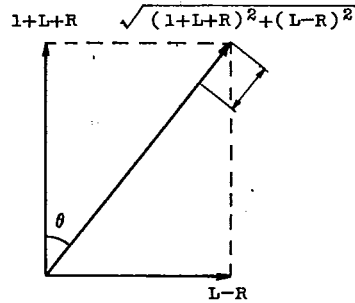

Fig. 1. Modulated-Wave Generation Principle of Motorola System (C-QUAM®)

ORTHOGONALLY MODULATED WAVE



Distortion caused by differential signal. The degree of distortion depends upon the level of the differential signal. (In case received with the monaural radio set.)

C-QUAM® WAVE

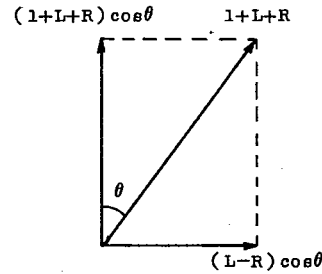

$$\cos \theta = \frac{1+L+R}{\sqrt{(1+L+R)^2 + (L-R)^2}}$$

cos θ component causes distortion (In case received with the orthogonally synchronous detection.)

Fig. 2. Difference Among Orthogonal Modulation, QUAM and C-QUAM®

9097247 TOSHIBA. ELECTRONIC

02E 17763 D

**TA8120P**

T-77-05-05

## 2. Distortion Elimination Through I (in-phase) Demodulation of Synchronous Detection

When C-QUAM<sup>®</sup> signal which is the transformation of QUAM signal is synchronously detected, directly the distortion of  $\cos\theta$  component is generated as shown in Fig.2. Therefore, the distortion is eliminated through the procedures described below. C-QUAM<sup>®</sup> signal is converted into QUAM signal by means of comparing the envelope detection output and I (in-phase) demodulation output made through the in-phase synchronous by using the error AMP., and by means of negatively feeding back the output.

This QUAM signal is orthogonally and synchronously detected to obtain Q demodulated output having small distortion.

## 3. Pilot Detection and Pilot Interference Detection Circuit

In adequate receiving condition, seven cycles of the pilot signal are counted leading to turn out the stereo mode. However, when the beat due to the interference signal is generated near 25Hz, the count mode of 37 cycles is instantaneously turned out.

The count-mode is reset every time when the interference is detected. Two kinds of procedures are available for detecting the interference as follows.

- (1) In case of beat generation due to the interference wave of the same frequency as that of the pilot signal 25Hz.

The state in which the amplitude is reduced due to the phase difference between the pilot signal and the beat signal is detected with 7-count mode.

For changing to the stereo mode, the modulation degree of minimum about 3% in seven cycles is necessary.

- (2) In case of beat generation near the pilot signal of 25Hz

Due to the resistance between the interference detection circuit and the pilot BPF output connected to the input 12 pin, the frequency characteristic of the interference detection input 12 pin becomes the notch characteristic of 25Hz with  $f_0$ .

By using this notch characteristic, the beat near 25Hz is detected.

The beat detection is to be performed at  $-43\text{dBm}$  ( $f=10\text{Hz}$ ).

The operations of (1) and (2) are made to be stopped when the stereo mode is once turned out.



**TA8120P**

T-77-05-05

#### 4. Interference Detection After Changeover to Stereo Mode

I demodulated output and Q demodulated output are observed in IC, and when the condition below is turned out, the mode is designed to be forcibly changed over to the monaural mode.

- (1) When PLL is unlocked.
- (2) When beat is generated according to neighboring interference.
- (3) When noise is generated in demodulation output due to reduction of input signal level.

#### 5. Sensitivity for Pilot-On

By changing the external constant, Q (band width) and  $A_0$  (sensitivity) can be altered.

Set Q and  $A_0$ , and determine  $R_a$ ~ $R_c$  with the expression below.

$$R_c = \frac{Q}{\pi f_0 C}$$

$$R_a = \frac{R_c}{2A_0}$$

$$R_b = \frac{R_a R_c}{4QR_a - R_c}$$

Note:  $A_0$  is the gain at  $f_0$ .

$$Q \leq 10$$

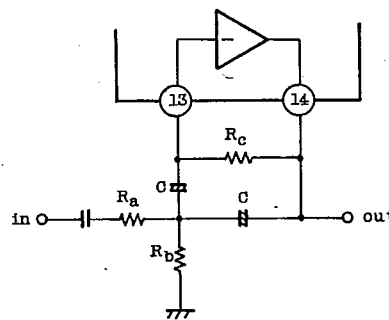
**AUDIO LINEAR IC**

**TA8120P**

T-77-05-05

## CAUTIONS FOR APPLICATION

1. For measuring the separation and the distortion in stereo mode, care must be taken because the characteristics change according to the modulation precision of the applied signal generator.
2. At measuring the above characteristics, the features described in the technical data are sometimes unable to be realized unless the modulation by the pilot signal is made off.  
This is caused by the fact that since the pilot signal of 25Hz leaks from the outputs L out and R out, the leakage is detected by the tester as the signals.
3. The output of AM tuner IC is connected to the input IF in of the medium frequency signal.  
If the noise or the spurious other than the medium frequency signal is contained, the noise or the spurious is detected and the phenomena below are liable to be generated.  
Use this IC after enough investigation of AM tuner IC to be connected to the fore stage.
  - (a) When antenna input is no-signal, detection output noise grows large.
  - (b) S/N at stereo mode deteriorates.

# TA8120P

T-77-05-05

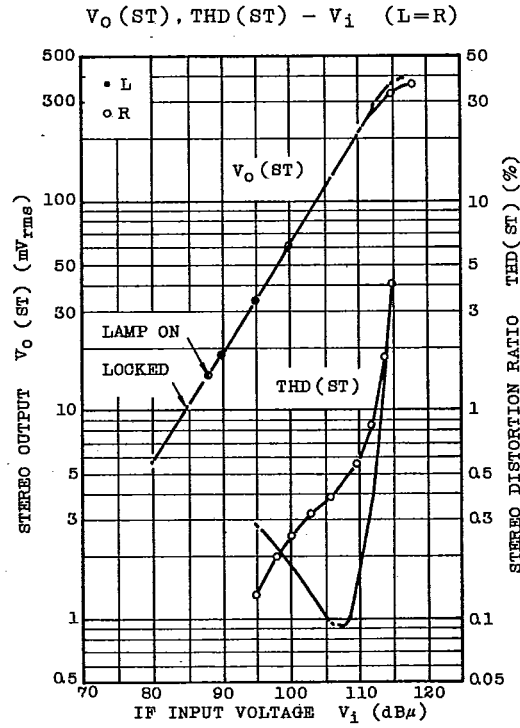
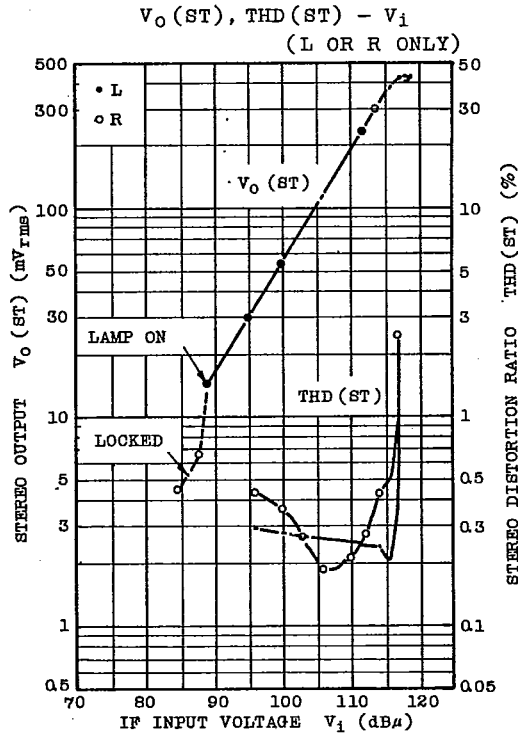
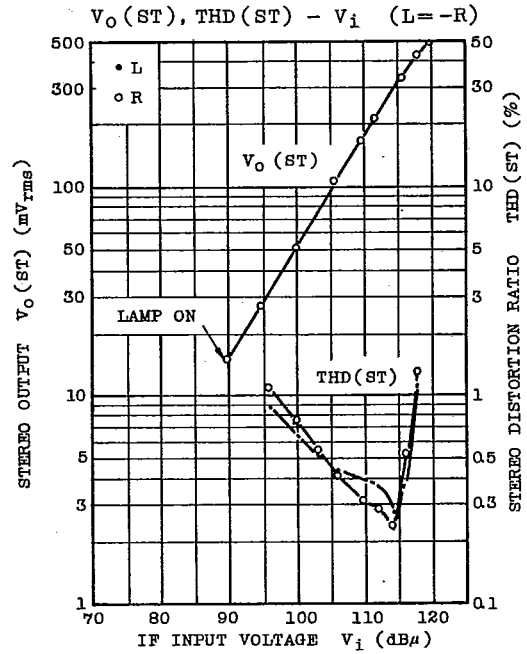
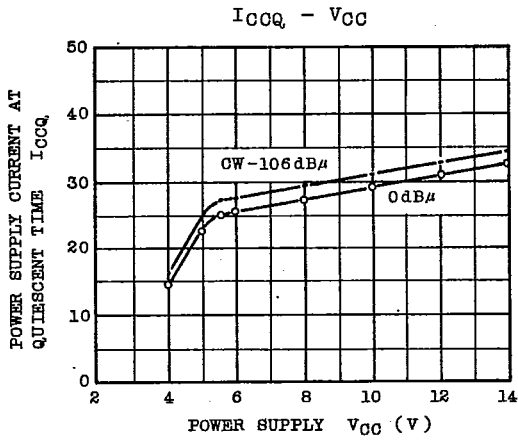

AUDIO LINEAR IC

**TA8120P**

T-77-05-05

Sep,  $V_o$  (ST), THD (ST) -  $f_m$  (L=R, L OR R ONLY)

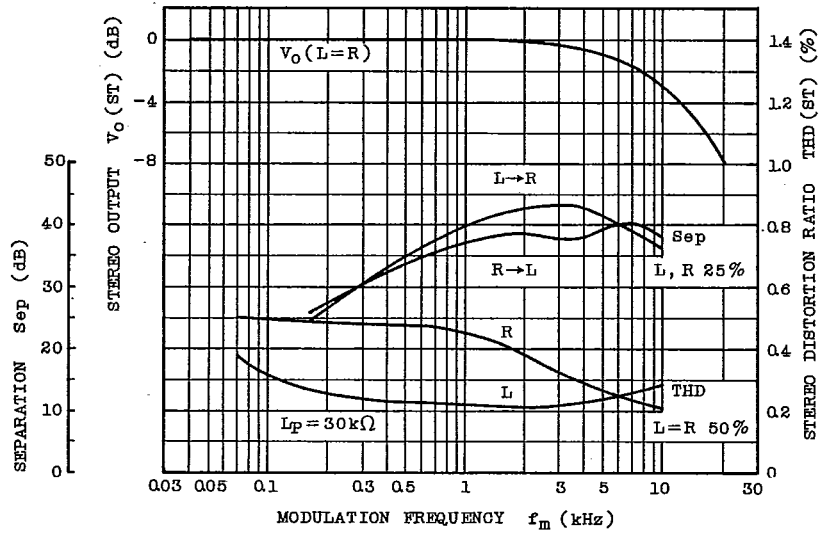

$V_o$  (ST), THD (ST) -  $f_m$  (L=-R)

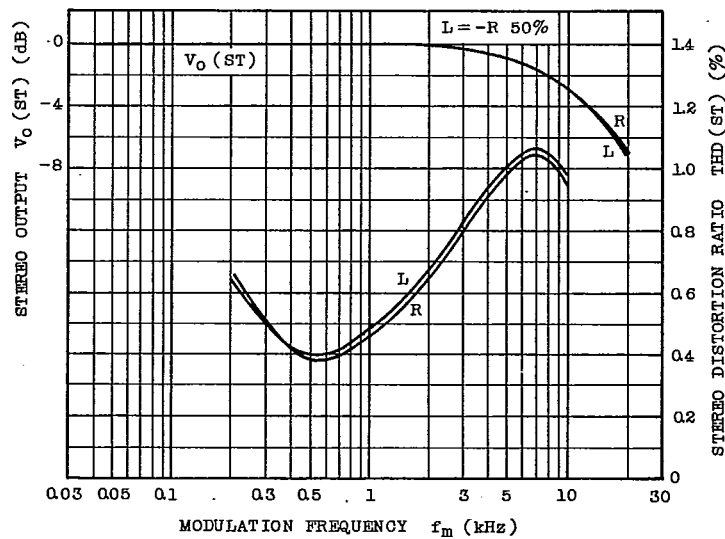

# TA8120P

T-77-05-05

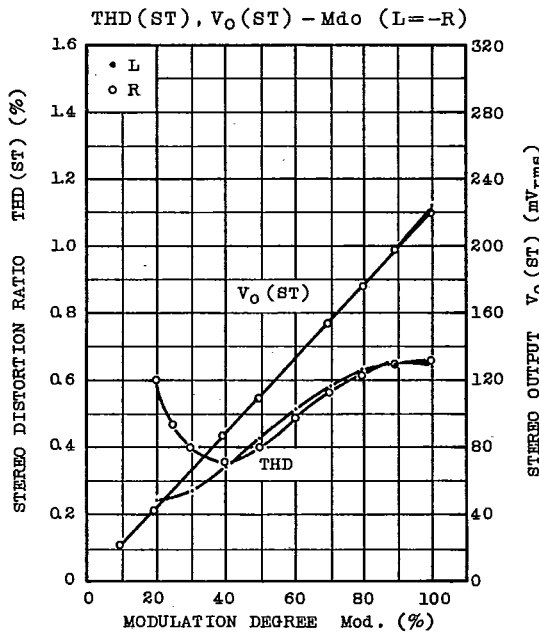
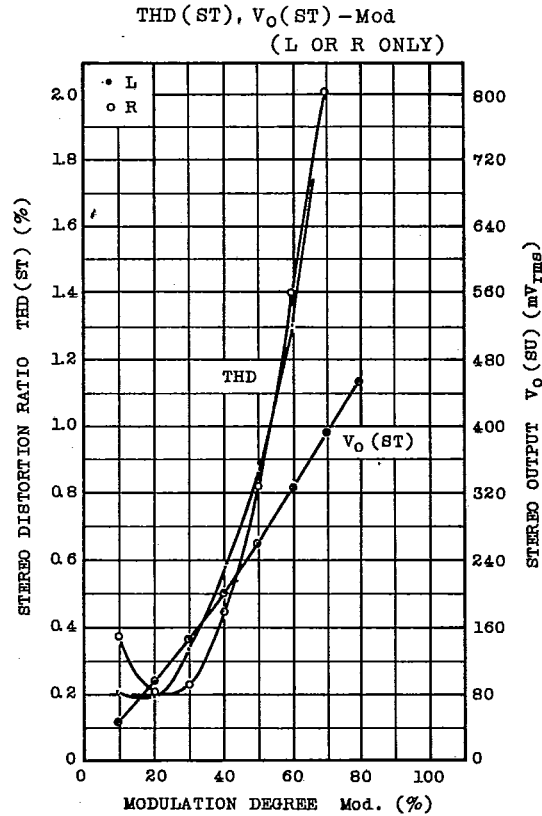
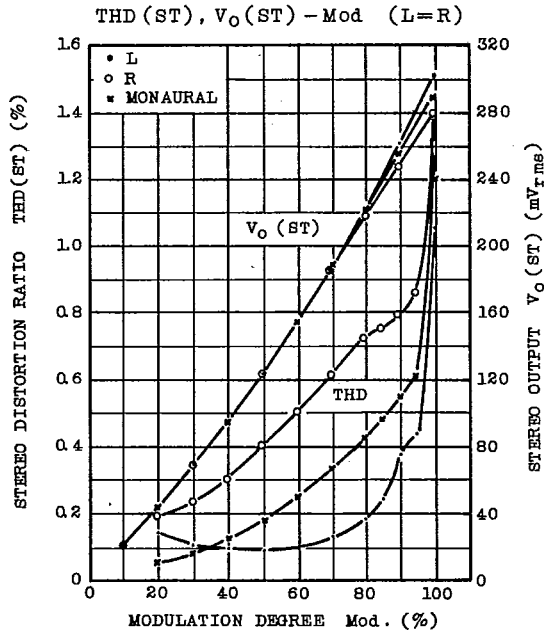

AUDIO LINEAR IC

TA8120P

T-77-05-05

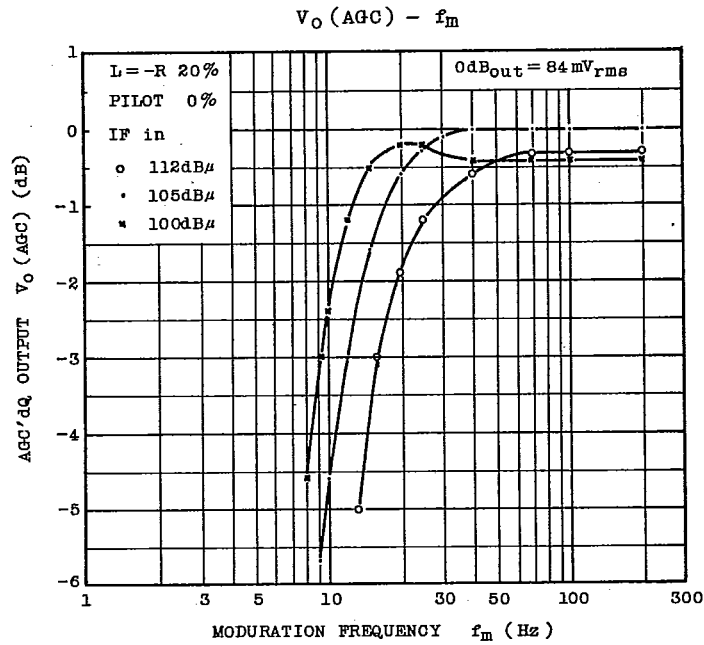
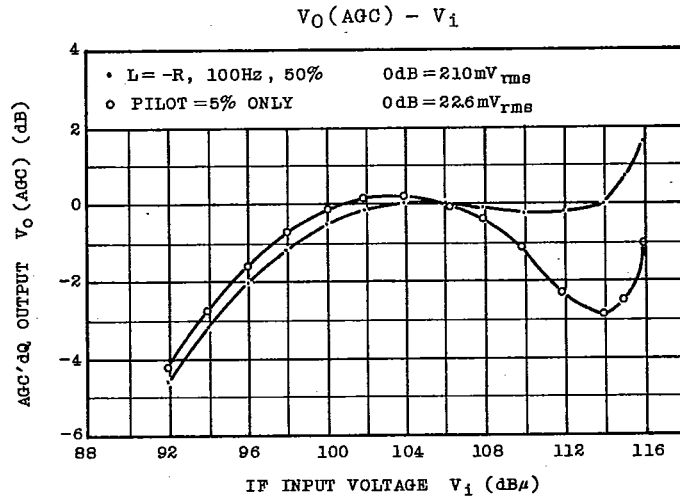

# TA8120P

T-77-05-05

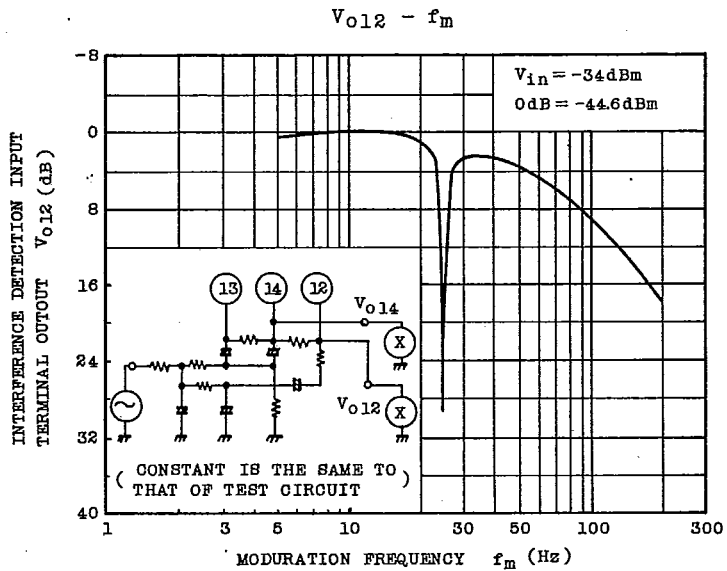
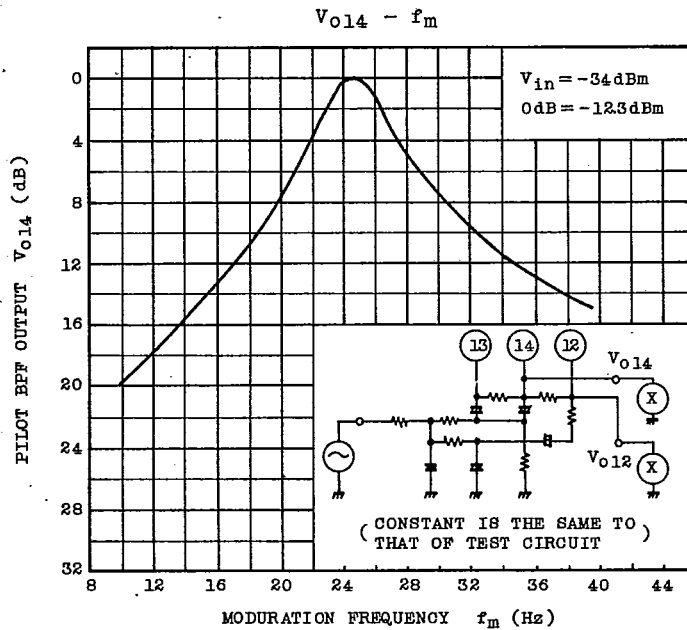

AUDIO LINEAR IC

# TA8120P

T-77-05-05

